



OLSEN
ATTACH

EXCAVATOR ATTACHMENTS PRICE BOOK : V9 2024

SPECS AND PRICING

-All prices are in New Zealand Dollars, excluding GST and freight.

-Pricing and specifications are subject to change.

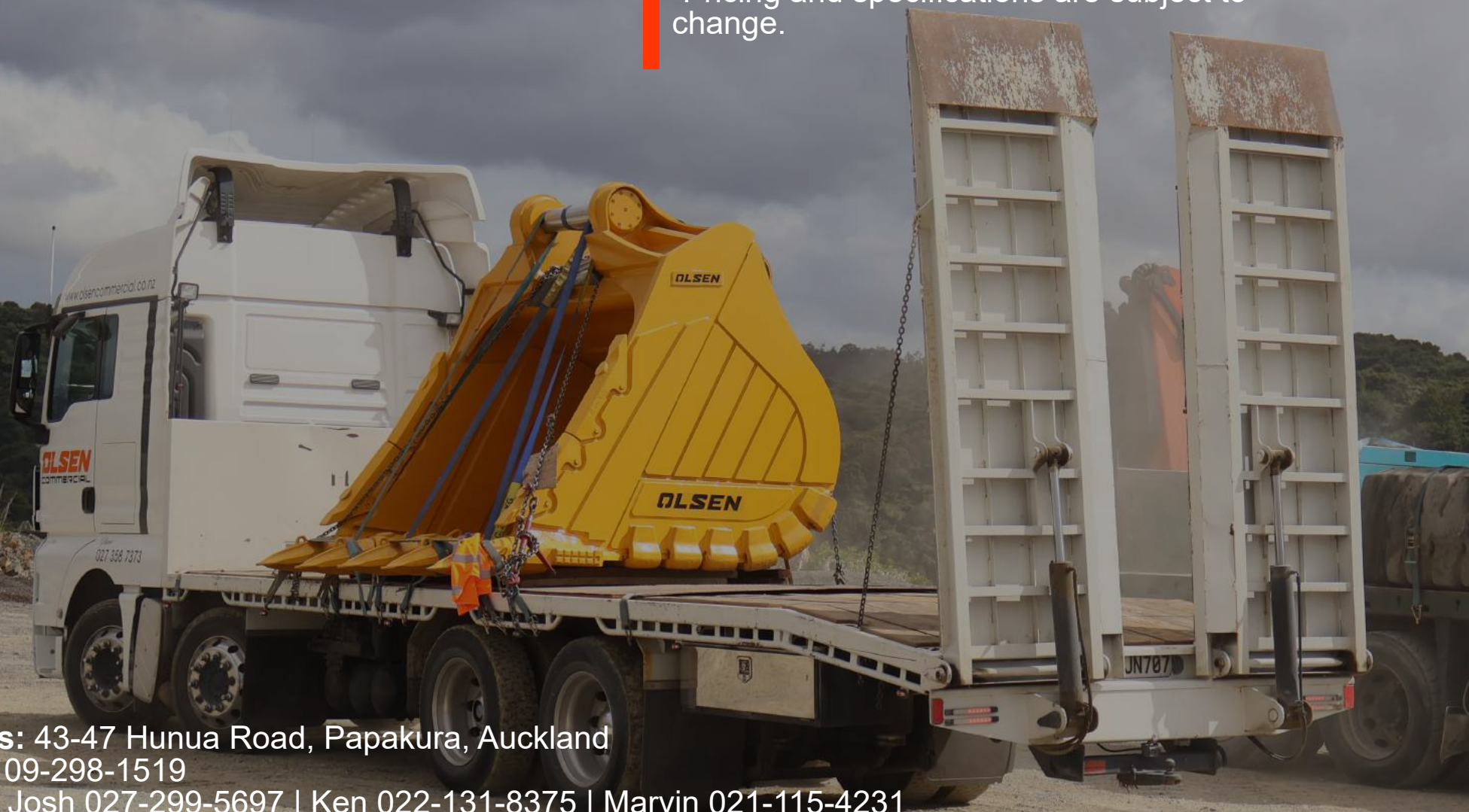

Address: 43-47 Hunua Road, Papakura, Auckland

Phone: 09-298-1519









Mobile: Josh 027-299-5697 | Ken 022-131-8375 | Marvin 021-115-4231

Email: sales@olsencommercial.co.nz

Website: www.olsenattachments.co.nz

PRICING AND SPECIFICATIONS: 1-1.9 TON



COUPLERS 1-1.9TON	PRODUCT CODE	PRODUCT NAME	WEIGHT (kg)	WIDTH (mm)	CAPACITY STRUCK (m ³)	CAPACITY HEAPED (m ³)	NO. OF TEETH	TILT RANGE (degrees)	DESCRIPTION	PRICE (EX GST)
	OADP-01	Draw Pin Hitch	14	-	-	-	-	-	Standard draw pin hitch with hardened greaseable pins.	\$550
BUCKETS 1-1.9TON	PRODUCT CODE	PRODUCT NAME	WEIGHT (kg)	WIDTH (mm)	CAPACITY STRUCK (m ³)	CAPACITY HEAPED (m ³)	NO. OF TEETH	TILT RANGE (degrees)	DESCRIPTION	PRICE (EX GST)
	OATB-01-900	Tilt Bucket-900mm	86	900	0.045	0.059	-	45	Single ram with ram guard. Pins and hoses are included.	\$2,610
	OAWB-01-900	Weed Bucket-900mm	66	900	0.060	0.079	-	-	Standard wide bucket. Pins are included.	\$960
	OADBNT-01-200	Dig Bucket-200mm	26	200	0.016	0.018	-	-	Trench bucket without teeth. Pins are included.	\$450
	OADBNT-01-300	Dig Bucket-300mm	32	300	0.025	0.030	-	-	Trench bucket without teeth. Pins are included.	\$520
	OADB-01-200	Dig Bucket-200mm	28	200	0.016	0.018	3	-	Trench bucket with teeth. Pins are included.	\$500
	OADB-01-300	Dig Bucket-300mm	34	300	0.025	0.030	3	-	Dig bucket with teeth. Pins are included.	\$570
	OADB-01-400	Dig Bucket-400mm	42	400	0.030	0.040	4	-	Dig bucket with teeth. Pins are included.	\$630
	OABS-01-300	Spade Frame & Insert-200mm/300mm	32	200/300	-	-	-	-	Spade frame and insert. Pins are included.	\$600
	OASS-01-200	Shallow Spade Bucket-200mm	24	200	-	-	-	-	Shallow spade bucket. Pins are included.	\$390
	OASS-01-300	Shallow Spade Bucket-300mm	26	300	-	-	-	-	Shallow spade bucket. Pins are included.	\$416
	OASP-01-200	Spade Bucket-200mm	20	200	-	-	-	-	Standard spade bucket. Pins are included.	\$420
	OASP-01-300	Spade Bucket-300mm	26	300	-	-	-	-	Standard spade bucket. Pins are included.	\$450

43-47 Hunua Road, Papakura, Auckland, 2110

Phone: 09-298-1519



Mobile: Josh 027-299-5697 | Ken 022-131-8375 | Marvin 021-115-4231









Email: sales@olsencommercial.co.nz

www.olsenattachments.co.nz

PRICING AND SPECIFICATIONS: 1-1.9 TON



GRABS 1-1.9TON	PRODUCT CODE	PRODUCT NAME	WEIGHT (kg)	WIDTH (mm)	CAPACITY STRUCK (m3)	CAPACITY HEAPED (m3)	NO. OF TEETH	OPENING (mm)	DESCRIPTION	PRICE (EX GST)
	OAGB-01	Grapple Bucket	100	300	-	-	-	494	Pins and hoses are included.	\$2,850
	OAHG-01	Demolition Grab	90	-	-	-	-	550	Pins and hoses are included.	\$2,350
	OAUG-01	Hydraulic Grapple	104	-	-	-	-	1000	Pin, hoses and hanging bracket are included.	\$2,660

ATTACHMENTS 1-1.9TON	PRODUCT CODE	PRODUCT NAME	WEIGHT (kg)	WIDTH (mm)	CAPACITY STRUCK (m3)	CAPACITY HEAPED (m3)	NO. OF TEETH	NO. OF TYNES	DESCRIPTION	PRICE (EX GST)
	OAPC-01	Plate Compactor	156	-	-	-	-	-	Hydraulic plate compactor. Pins and hoses are included.	\$4,560
	OACW-01	Compaction Wheel	78	230	-	-	-	-	Padfoot/ sheepsfoot design. Pins are included.	\$2,400
	OAHT-01	Hydraulic Thumb	58	-	-	-	-	-	Claw type hydraulic thumb.	\$1,640
	OARI-01	Ripper	32	-	-	-	1	-	Standard ripper with a replaceable tooth. Pins are included.	\$515
	OARR-01-1000	Root Rake-1000mm	50	1000	-	-	-	9	Standard root rake. Pins are included.	\$1,120
	OASR-01-1000	Scoop Rake-1000mm	57	1000	-	-	-	8	Standard scoop rake. Pins are included.	\$1,160
	OABP-01	Breaker	110	-	-	-	-	-	Includes accessory kit, pointed chisel and hoses.	\$4,850
	OALS-01	Log Splitter	145	-	-	-	-	-	9.3ton max. splitting force, 338mm max. log length and 200mm max. log diameter	\$3,050
	OAAU-01-X2000	Auger-X2000	105	-	-	-	-	-	Includes a hanging bracket, 450mm earth auger, and hoses.	\$3,890

43-47 Hunua Road, Papakura, Auckland, 2110

Phone: 09-298-1519





Mobile: Josh 027-299-5697 | Ken 022-131-8375 | Marvin 021-115-4231

Email: sales@olsencommercial.co.nz

www.olsenattachments.co.nz

PRICING AND SPECIFICATIONS: 2-2.9 TON



BUCKETS 2-2.9TON	PRODUCT CODE	PRODUCT NAME	WEIGHT (kg)	WIDTH (mm)	CAPACITY STRUCK (m ³)	CAPACITY HEAPED (m ³)	NO. OF TEETH	TILT RANGE (degrees)	DESCRIPTION	PRICE (EX GST)
	OATB-02-1000	Tilt Bucket-1000mm	174	1000	0.100	0.134	-	45	Single ram with ram guard. Pins and hoses are included.	\$3,670
	OAWB-02-1100	Weed Bucket -1100mm	90	1100	0.090	0.120	-	-	Standard wide bucket. Pins are included.	\$1,315
	OADB-02-300	Dig Bucket-300mm	64	300	0.034	0.042	3	-	Trench bucket with teeth. Pins are included.	\$860
	OADB-02-400	Dig Bucket-400mm	70	400	0.050	0.059	3	-	Dig bucket with teeth. Pins are included.	\$920
	OADB-02-450	Dig Bucket-450mm	80	450	0.054	0.067	4	-	Dig bucket with teeth. Pins are included.	\$950
	OADB-02-600	Dig Bucket-600mm	94	600	0.079	0.093	5	-	Dig bucket with teeth. Pins are included.	\$1,130
	OASS-02-300	Shallow Spade Bucket-300mm	48	300	-	-	-	-	Shallow spade bucket. Pins are included.	\$640
	OASS-02-400	Shallow Spade Bucket-400mm	54	400	-	-	-	-	Shallow spade bucket. Pins are included.	\$740
	OASP-02-300	Spade Bucket-300mm	38	300	-	-	-	-	Standard spade bucket. Pins are included.	\$580
	OASP-02-350	Spade Bucket-350mm	44	350	-	-	-	-	Standard spade bucket. Pins are included.	\$610
	OASP-02-400	Spade Bucket-400mm	48	400	-	-	-	-	Standard spade bucket. Pins are included.	\$640
	OASP-02-450	Spade Bucket-450mm	54	450	-	-	-	-	Standard spade bucket. Pins are included.	\$680

43-47 Hunua Road, Papakura, Auckland, 2110

Phone: 09-298-1519



Mobile: Josh 027-299-5697 | Ken 022-131-8375 | Marvin 021-115-4231







Email: sales@olsencommercial.co.nz

www.olsenattachments.co.nz

PRICING AND SPECIFICATIONS: 2-2.9 TON



GRABS 2-2.9TON	PRODUCT CODE	PRODUCT NAME	WEIGHT (kg)	WIDTH (mm)	CAPACITY STRUCK (m ³)	CAPACITY HEAPED (m ³)	NO. OF TEETH	OPENING (mm)	DESCRIPTION	PRICE (EX GST)
	OAGB-02	Grapple Bucket	170	420	-	-	-	700	Pins and hoses are included.	\$3,050
	OAHG-02	Demolition Grab	184	-	-	-	-	750	Pins and hoses are included.	\$4,210

ATTACHMENTS 2-2.9TON	PRODUCT CODE	PRODUCT NAME	WEIGHT (kg)	WIDTH (mm)	CAPACITY STRUCK (m ³)	CAPACITY HEAPED (m ³)	NO. OF TEETH	NO. OF TYNES	DESCRIPTION	PRICE (EX GST)
	OACW-02	Compaction Wheel	145	250	-	-	-	-	Padfoot/ sheepsfoot design. Pins are included.	\$2,720
	OARI-02	Ripper	46	-	-	-	1	-	Standard ripper with a replaceable tooth. Pins are included.	\$640
	OARR-02-1200	Root Rake-1200mm	120	1200	-	-	-	9	Standard root rake. Pins are included.	\$2,080
	OASR-02-1200	Scoop Rake-1200mm	114	1200	-	-	-	8	Standard scoop rake. Pins are included.	\$2,200
	OABP-02	Breaker	110	-	-	-	-	-	Includes accessory kit, pointed chisel and hoses.	\$4,950
	OALS-02	Log Splitter	160	-	-	-	-	-	9.3ton max. splitting force, 538mm max. log length and 200mm max. log diameter	\$3,650
	OAAU-02-X2500	Auger-X2500	115	-	-	-	-	-	Includes a hanging bracket, 450mm earth auger, and hoses.	\$4,200

43-47 Hunua Road, Papakura, Auckland, 2110

Phone: 09-298-1519





Mobile: Josh 027-299-5697 | Ken 022-131-8375 | Marvin 021-115-4231

Email: sales@olsencommercial.co.nz

www.olsenattachments.co.nz



PRICING AND SPECIFICATIONS: 3-3.9 TON









BUCKETS 3-3.9TON	PRODUCT CODE	PRODUCT NAME	WEIGHT (kg)	WIDTH (mm)	CAPACITY STRUCK (m ³)	CAPACITY HEAPED (m ³)	NO. OF TEETH	TILT RANGE (degrees)	DESCRIPTION	PRICE (EX GST)
	OATB-03-1200	Tilt Bucket-1200mm	-	1200	0.120	0.160	-	45	Twin ram design. Pins and hoses are included.	\$3,870
	OAWB-03-1200	Weed Bucket -1200mm	106	1200	0.120	0.160	-	-	Standard wide bucket. Pins are included.	\$1,380
	OADB-03-300	Dig Bucket-300mm	66	300	0.034	0.042	3	-	Trench bucket with teeth. Pins are included.	\$870
	OADB-03-400	Dig Bucket-400mm	75	400	0.045	0.059	3	-	Dig bucket with teeth. Pins are included.	\$930
	OADB-03-450	Dig Bucket-450mm	85	450	0.055	0.067	4	-	Dig bucket with teeth. Pins are included.	\$960
	OADB-03-600	Dig Bucket-600mm	99	600	0.076	0.093	5	-	Dig bucket with teeth. Pins are included.	\$1,140
	OASS-03-300	Shallow Spade Bucket-300mm	53	300	-	-	-	-	Shallow spade bucket. Pins are included.	\$650
	OASS-03-400	Shallow Spade Bucket-400mm	59	400	-	-	-	-	Shallow spade bucket. Pins are included.	\$750
	OASP-03-300	Spade Bucket-300mm	43	300	-	-	-	-	Standard spade bucket. Pins are included.	\$590
	OASP-03-350	Spade Bucket-350mm	49	350	-	-	-	-	Standard spade bucket. Pins are included.	\$620
	OASP-03-400	Spade Bucket-400mm	53	400	-	-	-	-	Standard spade bucket. Pins are included.	\$650
	OASP-03-450	Spade Bucket-450mm	59	450	-	-	-	-	Standard spade bucket. Pins are included.	\$690

PRICING AND SPECIFICATIONS: 3-3.9 TON



GRABS 3-3.9TON	PRODUCT CODE	PRODUCT NAME	WEIGHT (kg)	WIDTH (mm)	CAPACITY STRUCK (m3)	CAPACITY HEAPED (m3)	NO. OF TEETH	OPENING (mm)	DESCRIPTION	PRICE (EX GST)
	OAGB-03	Grapple Bucket	172	420	-	-	-	700	Pins and hoses are included.	\$3,350
	OAHG-03	Demolition Grab	184	-	-	-	-	750	Pins and hoses are included.	\$4,250

ATTACHMENTS 3-3.9TON	PRODUCT CODE	PRODUCT NAME	WEIGHT (kg)	WIDTH (mm)	CAPACITY STRUCK (m3)	CAPACITY HEAPED (m3)	NO. OF TEETH	NO. OF TYNES	DESCRIPTION	PRICE (EX GST)
	OACW-03	Compaction Wheel	150	250	-	-	-	-	Padfoot/ sheepsfoot design. Pins are included.	\$2,750
	OARI-03	Ripper	49	-	-	-	1	-	Standard ripper with a replaceable tooth. Pins are included.	\$700
	OARR-03-1200	Root Rake-1200mm	125	1200	-	-	-	9	Standard root rake. Pins are included.	\$2,110
	OASR-03-1200	Scoop Rake-1200mm	118	1200	-	-	-	8	Standard scoop rake. Pins are included.	\$2,250
	OABP-03	Breaker	150	-	-	-	-	-	Includes accessory kit, pointed chisel and hoses.	\$5,050
	OAAU-03-X2500	Auger-X2500	118	-	-	-	-	-	Includes a hanging bracket, 450mm earth auger, and hoses.	\$4,200





43-47 Hunua Road, Papakura, Auckland, 2110
Phone: 09-298-1519

Mobile: Josh 027-299-5697 | Ken 022-131-8375 | Marvin 021-115-4231
Email: sales@olsencommercial.co.nz
www.olsenattachments.co.nz

PRICING AND SPECIFICATIONS: 4-5.9 TON



COUPLERS 4-5.9TON	PRODUCT CODE	PRODUCT NAME	WEIGHT (kg)	WIDTH (mm)	CAPACITY STRUCK (m ³)	CAPACITY HEAPED (m ³)	NO. OF TEETH	TILT RANGE (degrees)	DESCRIPTION	PRICE (EX GST)
	OADC-05	Double Lock Quick Coupler	-	-	-	-	-	-	Hydraulic double lock quick coupler.	\$2,560



BUCKETS 4-5.9TON	PRODUCT CODE	PRODUCT NAME	WEIGHT (kg)	WIDTH (mm)	CAPACITY STRUCK (m ³)	CAPACITY HEAPED (m ³)	NO. OF TEETH	TILT RANGE (degrees)	DESCRIPTION	PRICE (EX GST)
	OATB-05-1400	Tilt Bucket-1400mm	314	1400	0.240	0.310	-	45	Double ram design. Pins, bolt on cutting edge and hoses are included.	\$4,790
	OAWB-05-1400	Weed Bucket-1400mm	237	1400	0.220	0.280	-	-	Standard wide bucket. Pins and bolt on cutting edge are included.	\$2,080
	OAWB-05-1500	Weed Bucket-1500mm	245	1500	0.230	0.300	-	-	Standard wide bucket. Pins and bolt on cutting edge are included.	\$2,140
	OADBNT-05-300	Dig Bucket-300mm	100	300	0.065	0.080	-	-	Trench bucket without teeth. Pins are included.	\$960
	OADB-05-300	Dig Bucket-300mm	100	300	0.065	0.080	3	-	Trench bucket with teeth. Pins are included.	\$1,090
	OADB-05-400	Dig Bucket-400mm	118	400	0.085	0.110	4	-	Dig bucket with teeth. Pins are included.	\$1,150
	OADB-05-450	Dig Bucket-450mm	128	450	0.100	0.123	4	-	Dig bucket with teeth. Pins are included.	\$1,180
	OADB-05-600	Dig Bucket-600mm	140	600	0.140	0.170	5	-	Dig bucket with teeth. Pins are included.	\$1,330
	OASS-05-300	Shallow Spade Bucket-300mm	76	300	-	-	-	-	Shallow spade bucket. Pins are included.	\$960
	OASS-05-400	Shallow Spade Bucket-400mm	80	400	-	-	-	-	Shallow spade bucket. Pins are included.	\$1,060
	OASS-05-600	Shallow Spade Bucket-600mm	90	600	-	-	-	-	Shallow spade bucket. Pins are included.	\$1,160





43-47 Hunua Road, Papakura, Auckland, 2110
Phone: 09-298-1519

Mobile: Josh 027-299-5697 | Ken 022-131-8375 | Marvin 021-115-4231
Email: sales@olsencommercial.co.nz
www.olsenattachments.co.nz

PRICING AND SPECIFICATIONS: 4-5.9 TON



BUCKETS 4-5.9TON	PRODUCT CODE	PRODUCT NAME	WEIGHT (kg)	WIDTH (mm)	CAPACITY STRUCK (m ³)	CAPACITY HEAPED (m ³)	NO. OF TEETH	TILT RANGE (degrees)	DESCRIPTION	PRICE (EX GST)
	OASP-05-300	Spade Bucket-300mm	50	300	-	-	-	-	Standard spade bucket. Pins are included.	\$840
	OASP-05-350	Spade Bucket-350mm	54	350	-	-	-	-	Standard spade bucket. Pins are included.	\$860
	OASP-05-400	Spade Bucket-400mm	58	400	-	-	-	-	Standard spade bucket. Pins are included.	\$900
	OASP-05-450	Spade Bucket-450mm	64	450	-	-	-	-	Standard spade bucket. Pins are included.	\$920
	OASP-05-600	Spade Bucket-600mm	70	600	-	-	-	-	Standard spade bucket. Pins are included.	\$980
	OASB-05-1400	Wide Screen Bucket-1400mm	252	1400	0.320	0.410	-	-	80mm*100mm hole size. Pins are included.	\$2,240

GRABS 4-5.9TON	PRODUCT CODE	PRODUCT NAME	WEIGHT (kg)	WIDTH (mm)	CAPACITY STRUCK (m ³)	CAPACITY HEAPED (m ³)	NO. OF TEETH	OPENING (mm)	DESCRIPTION	PRICE (EX GST)
	OAGB-05	Grapple Bucket	280	450	-	-	-	707	Pins and hoses are included.	\$4,850
	OAHG-05	Demolition Grab	262	-	-	-	-	892	Pins and hoses are included.	\$4,370
	OAUG-05	Hydraulic Grapple	204	-	-	-	-	1230	Pin, hoses and hanging bracket are included.	\$3,500
	OAAO-05	All in One Bucket	236	600	-	-	-	468	Pins and hoses are included.	\$3,890

43-47 Hunua Road, Papakura, Auckland, 2110

Phone: 09-298-1519









Mobile: Josh 027-299-5697 | Ken 022-131-8375 | Marvin 021-115-4231

Email: sales@olsencommercial.co.nz

www.olsenattachments.co.nz

PRICING AND SPECIFICATIONS: 4-5.9 TON







ATTACHMENTS 4-5.9TON	PRODUCT CODE	PRODUCT NAME	WEIGHT (kg)	WIDTH (mm)	CAPACITY STRUCK (m3)	CAPACITY HEAPED (m3)	NO. OF TEETH	NO. OF TYNES	DESCRIPTION	PRICE (EX GST)
	OAPC-05	Plate Compactor	304	-	-	-	-	-	Hydraulic plate compactor. Pins, hoses and 300mm post ring included.	\$6,325
	OACW-05	Compaction Wheel	248	450	-	-	-	-	Padfoot/ sheepsfoot design. Pins are included.	\$2,980
	OARH-05	Hydraulic Thumb	84	-	-	-	-	-	RHS hydraulic thumb.	\$3,360
	OARI-05	Ripper	76	-	-	-	1	-	Standard ripper with a replaceable tooth. Pins are included.	\$1,100
	OARR-05-1500	Root Rake-1500	400	1500	-	-	-	11	BIS 400 tips. Pins included.	\$2,630
	OASR-05-1500	Scoop Rake-1500	300	1500	-	-	-	8	BIS 400 tips. Pins included.	\$2,880
	OATS-05	Tree Shear	324	-	-	-	-	-	200mm max. cutting diameter	\$7,125
	OABP-05	Rock Breaker	350	-	-	-	-	-	Includes accessory kit, pointed chisel, and hoses.	\$5,080
	OAAU-05-4500	Auger-4500	142	-	-	-	-	-	Includes a hanging bracket, 450mm earth auger, and hoses.	\$4,880

PRICING AND SPECIFICATIONS: 6-9.9 TON



COUPLERS 6-9.9TON	PRODUCT CODE	PRODUCT NAME	WEIGHT (kg)	WIDTH (mm)	CAPACITY STRUCK (m ³)	CAPACITY HEAPED (m ³)	NO. OF TEETH	TILT RANGE (degrees)	DESCRIPTION	PRICE (EX GST)
	OADC-08	Double Lock Quick Coupler	-	-	-	-	-	-	Hydraulic double lock quick coupler.	\$2,935

BUCKETS 6-9.9TON	PRODUCT CODE	PRODUCT NAME	WEIGHT (kg)	WIDTH (mm)	CAPACITY STRUCK (m ³)	CAPACITY HEAPED (m ³)	NO. OF TEETH	TILT RANGE (degrees)	DESCRIPTION	PRICE (EX GST)
	OATB-08-1600	Tilt Bucket-1600mm	360	1600	0.350	0.460	-	45	Double ram design. Pins, bolt on cutting edge and hoses are included.	\$5,600
	OAWB-08-1600	Weed Bucket-1600mm	295	1600	0.300	0.400	-	-	Standard wide bucket. Pins and bolt on cutting edge are included.	\$2,560
	OADBNT-08-300	Dig Bucket-300mm	122	300	0.080	0.095	-	-	Trench bucket without teeth. Pins are included.	\$1,100
	OADB-08-300	Dig Bucket-300mm	124	300	0.080	0.095	3	-	Trench bucket with teeth. Pins are included.	\$1,480
	OADB-08-400	Dig Bucket-400mm	132	400	0.110	0.130	3	-	Dig bucket with teeth. Pins are included.	\$1,570
	OADB-08-450	Dig Bucket-450mm	166	450	0.120	0.150	4	-	Dig bucket with teeth. Pins are included.	\$1,600
	OADB-08-600	Dig Bucket-600mm	174	600	0.170	0.200	5	-	Dig bucket with teeth. Pins are included.	\$1,750
	OASS-08-300	Shallow Spade Bucket-300mm	101	300	-	-	-	-	Shallow spade bucket. Pins are included.	\$980
	OASS-08-400	Shallow Spade Bucket-400mm	110	400	-	-	-	-	Shallow spade bucket. Pins are included.	\$1,100
	OASS-08-600	Shallow Spade Bucket-600mm	129	600	-	-	-	-	Shallow spade bucket. Pins are included.	\$1,350

43-47 Hunua Road, Papakura, Auckland, 2110

Phone: 09-298-1519



Mobile: Josh 027-299-5697 | Ken 022-131-8375 | Marvin 021-115-4231



Email: sales@olsencommercial.co.nz

www.olsenattachments.co.nz

PRICING AND SPECIFICATIONS: 6-9.9 TON



BUCKETS 6-9.9TON	PRODUCT CODE	PRODUCT NAME	WEIGHT (kg)	WIDTH (mm)	CAPACITY STRUCK (m ³)	CAPACITY HEAPED (m ³)	NO. OF TEETH	TILT RANGE (degrees)	DESCRIPTION	PRICE (EX GST)
	OASP-08-300	Spade Bucket-300mm	54	300	-	-	-	-	Standard spade bucket. Pins are included.	\$960
	OASP-08-350	Spade Bucket-350mm	60	350	-	-	-	-	Standard spade bucket. Pins are included.	\$1,030
	OASP-08-400	Spade Bucket-400mm	66	400	-	-	-	-	Standard spade bucket. Pins are included.	\$1,060
	OASP-08-450	Spade Bucket-450mm	76	450	-	-	-	-	Standard spade bucket. Pins are included.	\$1,090
	OASP-08-600	Spade Bucket-600mm	133	600	-	-	-	-	Standard spade bucket. Pins are included.	\$1,280
	OASI-08-800	Sieve Bucket-800mm	190	800	0.230	0.270	-	-	150mm*100mm hole size. Pins are included.	\$2,400
	OAWSB-08-1600	Wide Screen Bucket-1600mm	310	1600	0.400	0.550	-	-	80mm*100mm hole size. Pins are included.	\$2,600

GRABS 6-9.9TON	PRODUCT CODE	PRODUCT NAME	WEIGHT (kg)	WIDTH (mm)	CAPACITY STRUCK (m3)	CAPACITY HEAPED (m3)	NO. OF TEETH	OPENING (mm)	DESCRIPTION	PRICE (EX GST)
	OAGB-08	Grapple bucket	334	500	-	-	-	806	Pins and hoses are included.	\$5,170
	OAHG-08	Demolition Grab	324	-	-	-	-	892	Pins and hoses are included.	\$4,530

43-47 Hunua Road, Papakura, Auckland, 2110

Phone: 09-298-1519







Mobile: Josh 027-299-5697 | Ken 022-131-8375 | Marvin 021-115-4231

Email: sales@olsencommercial.co.nz

www.olsenattachments.co.nz

PRICING AND SPECIFICATIONS: 6-9.9 TON









ATTACHMENTS 6-9.9TON	PRODUCT CODE	PRODUCT NAME	WEIGHT (kg)	WIDTH (mm)	CAPACITY STRUCK (m3)	CAPACITY HEAPED (m3)	NO. OF TEETH	NO. OF TYNES	DESCRIPTION	PRICE (EX GST)
	OAPC-08	Plate Compactor	320	-	-	-	-	-	Hydraulic plate compactor. Pins, hoses and 300mm post ring included.	\$6,965
	OACW-08	Compaction Wheel	260	450	-	-	-	-	Padfoot/ sheepsfoot design. Pins are included.	\$3,040
	OARH-08	Hydraulic Thumb	100	-	-	-	-	-	RHS hydraulic thumb.	\$3,300
	OARI-08	Ripper	96	-	-	-	1	-	Standard ripper with a replaceable tooth. Pins are included.	\$1,300
	OARR-08-1600	Root Rake-1600mm	400	1600	-	-	-	11	BIS 400 tips. Pins included.	\$3,040
	OASR-08-1600	Scoop Rake-1600mm	380	1600	-	-	-	8	BIS 400 tips. Pins included.	\$3,360
	OATS-08	Tree Shear	566	-	-	-	-	-	300mm max. cutting diameter	\$11,100

43-47 Hunua Road, Papakura, Auckland, 2110
Phone: 09-298-1519

Mobile: Josh 027-299-5697 | Ken 022-131-8375 | Marvin 021-115-4231
Email: sales@olsencommercial.co.nz
www.olsenattachments.co.nz

PRICING AND SPECIFICATIONS: 10-14.9 TON



COUPLERS 10-14.9TON	PRODUCT CODE	PRODUCT NAME	WEIGHT (kg)	WIDTH (mm)	CAPACITY STRUCK (m ³)	CAPACITY HEAPED (m ³)	NO. OF TEETH	TILT RANGE (degrees)	DESCRIPTION	PRICE (EX GST)
	OADC-12	Double Lock Quick Hitch Coupler	256	-	-	-	-	-	Hydraulic double lock quick coupler.	\$3,880
BUCKETS 10-14.9TON	PRODUCT CODE	PRODUCT NAME	WEIGHT (kg)	WIDTH (mm)	CAPACITY STRUCK (m ³)	CAPACITY HEAPED (m ³)	NO. OF TEETH	TILT RANGE (degrees)	DESCRIPTION	PRICE (EX GST)
	OATB-12-1800	Tilt Bucket-1800mm	600	1800	0.570	0.760	-	45	Double ram design. Pins, bolt on cutting edge and hoses are included.	\$8,280
	OAWB-12-1800	Weed Bucket -1800mm	553	1800	0.540	0.710	-	-	Standard wide bucket. Pins and bolt on cutting edge are included.	\$4,800
	OADBNT-12-400	Dig bucket-400mm	294	400	0.190	0.220	-	-	Trench bucket without teeth. Pins are included.	\$2,300
	OADB-12-400	Dig Bucket-400mm	316	400	0.190	0.220	3	-	Dig bucket with teeth. Pins are included.	\$2,750
	OADB-12-600	Dig Bucket-600mm	354	600	0.300	0.340	3	-	Dig bucket with teeth. Pins are included.	\$2,950
	OADB-12-900	Dig Bucket-900mm	420	900	0.440	0.520	5	-	Dig bucket with teeth. Pins are included.	\$3,310
	OADB-12-1100	Dig Bucket-1100mm	500	1100	0.550	0.650	5	-	Dig bucket with teeth. Pins are included.	\$3,600
	OARB-12-900	Rock Bucket-900mm	584	900	0.430	0.510	5	-	Rock bucket with teeth. Pins are included.	\$3,500
	OASS-12-300	Shallow Spade Bucket-300mm	144	300	-	-	-	-	Shallow spade bucket. Pins are included.	\$1,400
	OASS-12-400	Shallow Spade Bucket-400mm	156	400	-	-	-	-	Shallow spade bucket. Pins are included.	\$1,500
	OASS-12-600	Shallow Spade Bucket-600mm	178	600	-	-	-	-	Shallow spade bucket. Pins are included.	\$1,800

43-47 Hunua Road, Papakura, Auckland, 2110

Phone: 09-298-1519





Mobile: Josh 027-299-5697 | Ken 022-131-8375 | Marvin 021-115-4231



Email: sales@olsencommercial.co.nz

www.olsenattachments.co.nz

PRICING AND SPECIFICATIONS: 10-14.9 TON



BUCKETS 10-14.9TON	PRODUCT CODE	PRODUCT NAME	WEIGHT (kg)	WIDTH (mm)	CAPACITY STRUCK (m ³)	CAPACITY HEAPED (m ³)	NO. OF TEETH	TILT RANGE (degrees)	DESCRIPTION	PRICE (EX GST)
	OASP-12-300	Spade Bucket-300mm	138	300	-	-	-	-	Standard spade bucket. Pins are included.	\$1,300
	OASP-12-350	Spade Bucket-350mm	148	350	-	-	-	-	Standard spade bucket. Pins are included.	\$1,330
	OASP-12-400	Spade Bucket-400mm	158	400	-	-	-	-	Standard spade bucket. Pins are included.	\$1,360
	OASP-12-450	Spade Bucket-450mm	168	450	-	-	-	-	Standard spade bucket. Pins are included.	\$1,440
	OASP-12-600	Spade Bucket-600mm	192	600	-	-	-	-	Standard spade bucket. Pins are included.	\$1,600
	OASI-12-1100	Sieve Bucket-1100mm	580	1100	0.500	0.560	5	-	150mm*100mm hole size. Pins are included.	\$4,630
	OAWSB-12-1800	Wide Screen Bucket-1800	612	1800	0.800	1.050	-	-	100mm*150mm hole size. Pins are included.	\$6,400
	OATZB-12	Trapezoidal Bucket/ V Bucket	384	300/1100	0.260	0.360	-	-	1100mm top overall width and 300mm base width.	\$3,200

GRABS 10-14.9TON	PRODUCT CODE	PRODUCT NAME	WEIGHT (kg)	WIDTH (mm)	CAPACITY STRUCK (m ³)	CAPACITY HEAPED (m ³)	NO. OF TEETH	OPENING (mm)	DESCRIPTION	PRICE (EX GST)
	OAGB-12	Grapple Bucket	700	600	-	-	-	1214	Pins and hoses are included.	\$8,880
	OAHG-12	Demolition Grab	518	-	-	-	-	1088	Pins and hoses are included.	\$7,590

43-47 Hunua Road, Papakura, Auckland, 2110

Phone: 09-298-1519











Mobile: Josh 027-299-5697 | Ken 022-131-8375 | Marvin 021-115-4231

Email: sales@olsencommercial.co.nz

www.olsenattachments.co.nz

PRICING AND SPECIFICATIONS: 10-14.9 TON



ATTACHMENTS 10-14.9TON	PRODUCT CODE	PRODUCT NAME	WEIGHT (kg)	WIDTH (mm)	CAPACITY STRUCK (m3)	CAPACITY HEAPED (m3)	NO. OF TEETH	NO. OF TYNES	DESCRIPTION	PRICE (EX GST)
	OAPC-12	Plate Compactor	596	-	-	-	-	-	Hydraulic plate compactor. Pins and hoses included.	\$7,270
	OACW-12	Compaction Wheel	360	450	-	-	-	-	Padfoot/ sheepsfoot design. Pins are included.	\$5,320
	OARH-12	Hydraulic Thumb	210	-	-	-	-	-	RHS hydraulic thumb.	\$4,320
	OARI-12	Ripper	316	-	-	-	1	-	Standard ripper with a replaceable tooth. Pins are included.	\$2,600
	OADRR-12-1800	Doubleway Root Rake-1800mm	600	1800	-	-	-	9	BIS 400 tips. Pins included.	\$5,760
	OARR-12-1800	Root Rake-1800	620	-	-	-	-	7	BIS 400 tips. Pins included.	\$5,380
	OASR-12-1800	Scoop Rake-1800mm	620	-	-	-	-	8	BIS 400 tips. Pins included.	\$5,700
	OATS-12	Tree Shear	1066	-	-	-	-	-	400mm max. cutting diameter	\$16,650
	OABP-12	Rock Breaker	860	-	-	-	-	-	Includes accessory kit, pointed chisels and hoses.	\$11,900
	OAEA-12	Extension Arm	580	-	-	-	-	-	End fit for 50mm pin bucket	\$12,680





43-47 Hunua Road, Papakura, Auckland, 2110
Phone: 09-298-1519



Mobile: Josh 027-299-5697 | Ken 022-131-8375 | Marvin 021-115-4231
Email: sales@olsencommercial.co.nz
www.olsenattachments.co.nz

PRICING AND SPECIFICATIONS: 15-23.9 TON



COUPLERS 15-23.9TON	PRODUCT CODE	PRODUCT NAME	WEIGHT (kg)	WIDTH (mm)	CAPACITY STRUCK (m ³)	CAPACITY HEAPED (m ³)	NO. OF TEETH	TILT RANGE (degrees)	DESCRIPTION	PRICE (EX GST)
	OADC-20	Double Lock Quick Hitch Coupler	420	-	-	-	-	-	Hydraulic double lock quick coupler.	\$5,900

BUCKETS 15-23.9TON	PRODUCT CODE	PRODUCT NAME	WEIGHT (kg)	WIDTH (mm)	CAPACITY STRUCK (m ³)	CAPACITY HEAPED (m ³)	NO. OF TEETH	TILT RANGE (degrees)	DESCRIPTION	PRICE (EX GST)
	OATB-20-2000	Tilt Bucket-2000mm	1190	2000	1.020	1.340	-	45	Double ram design. Pins, bolt on cutting edge and hoses are included.	\$9,970
	OAWB-20-2000	Weed Bucket-2000mm	887	2000	0.820	1.070	-	-	Standard wide bucket. Pins and bolt on cutting edge are included.	\$7,040
	OADB-20-400	Dig Bucket-400mm	496	400	0.250	0.300	3	-	Dig bucket with teeth. Pins are included.	\$3,180
	OADB-20-600	Dig Bucket-600mm	548	600	0.380	0.450	3	-	Dig bucket with teeth. Pins are included.	\$3,360
	OADB-20-1100	Dig Bucket-1100mm	780	1100	0.750	0.900	5	-	Dig bucket with teeth. Pins are included.	\$4,800
	OASI-20-1500	Sieve Bucket-1500mm	1350	1500	1.010	1.150	5	-	100mm*100mm & 150mm*150mm hole size available. Pins are included.	\$8,640
	OATZB-20	Trapezoidal Bucket/ V Bucket	580	300/1500	0.400	0.550	-	-	1500mm top overall width and 300mm base width.	\$3,900









GRABS 15-23.9TON	PRODUCT CODE	PRODUCT NAME	WEIGHT (kg)	WIDTH (mm)	CAPACITY STRUCK (m ³)	CAPACITY HEAPED (m ³)	NO. OF TEETH	OPENING (mm)	DESCRIPTION	PRICE (EX GST)
	OAGB-20	Grapple Bucket	1170	700	-	-	-	1600	Pins and hoses are included.	\$9,970
	OAHG-20	Demolition Grab	1230	-	-	-	-	1397	Pins and hoses are included.	\$9,420

43-47 Hunua Road, Papakura, Auckland, 2110
Phone: 09-298-1519

Mobile: Josh 027-299-5697 | Ken 022-131-8375 | Marvin 021-115-4231
Email: sales@olsencommercial.co.nz
www.olsenattachments.co.nz

PRICING AND SPECIFICATIONS: 15-23.9 TON



ATTACHMENTS 15-23.9TON	PRODUCT CODE	PRODUCT NAME	WEIGHT (kg)	WIDTH (mm)	CAPACITY STRUCK (m3)	CAPACITY HEAPED (m3)	NO. OF TEETH	NO. OF TYNES	DESCRIPTION	PRICE (EX GST)
	OAPC-20	Plate Compactor	980	-	-	-	-	-	Hydraulic plate compactor. Pins, hoses and 300mm post ring included.	\$9,830
	OACW-20	Compaction wheel	784	580	-	-	-	-	Padfoot/ sheepsfoot design. Pins are included.	\$8,000
	OAHT-20	Hydraulic Thumb	326	-	-	-	-	-	RHS hydraulic thumb.	\$5,280
	OARI-20	Ripper	440	-	-	-	1	-	Standard ripper with a replaceable tooth. Pins are included.	\$4,000
	OADRR-20-2000	Doubleway Root Rake-2000mm	1196	2000	-	-	-	9	BIS 400 tips. Pins included.	\$8,320
	OARR-20-2000	Root Rake -2000mm	1214	2000	-	-	-	8	BIS 400 tips. Pins included.	\$8,000
	OASR-20-2000	Scoop Rake-2000mm	940	2000	-	-	-	8	BIS 400 tips. Pins included.	\$7,760
	OABP-20	Rock Breaker	1765	-	-	-	-	-	Includes accessory kit, pointed chisels and hoses.	\$18,930
	OATS-20	Tree Shear	1122	-	-	-	-	-	400mm max. cutting diameter	\$18,650

43-47 Hunua Road, Papakura, Auckland, 2110

Phone: 09-298-1519



Mobile: Josh 027-299-5697 | Ken 022-131-8375 | Marvin 021-115-4231

Email: sales@olsencommercial.co.nz

www.olsenattachments.co.nz

PRICING AND SPECIFICATIONS: 30 TON



BUCKETS 30TON	PRODUCT CODE	PRODUCT NAME	WEIGHT (kg)	WIDTH (mm)	CAPACITY STRUCK (m ³)	CAPACITY HEAPED (m ³)	NO. OF TEETH	TILT RANGE (degrees)	DESCRIPTION	PRICE (EX GST)
	OAWB-30-2200	Weed Bucket-2000mm	1346	2200	1.400	1.600	-	-	Standard wide bucket. Pins and bolt on cutting edge are included.	\$12,160
	OARB-30-1200	Rock Bucket-1200mm	1530	1200	1.050	1.300	5	-	Dig bucket with teeth. Pins are included.	\$10,240

GRABS 30TON	PRODUCT CODE	PRODUCT NAME	WEIGHT (kg)	WIDTH (mm)	CAPACITY STRUCK (m ³)	CAPACITY HEAPED (m ³)	NO. OF TEETH	OPENING (mm)	DESCRIPTION	PRICE (EX GST)
	OAGB-30	Grapple Bucket	1874	-	-	-	-	1900	Pins and hoses are included.	\$14,770

ATTACHMENTS 30TON	PRODUCT CODE	PRODUCT NAME	WEIGHT (kg)	WIDTH (mm)	CAPACITY STRUCK (m ³)	CAPACITY HEAPED (m ³)	NO. OF TEETH	NO. OF TYNES	DESCRIPTION	PRICE (EX GST)
	OARI-30	Ripper	818	-	-	-	1	-	Standard ripper with a replaceable tooth. Pins are included.	\$5,760

43-47 Hunua Road, Papakura, Auckland, 2110

Phone: 09-298-1519

Mobile: Josh 027-299-5697 | Ken 022-131-8375 | Marvin 021-115-4231

Email: sales@olsencommercial.co.nz

www.olsenattachments.co.nz

PARTS



BUCKET TOOTH	PRODUCT CODE	TONNAGE (ton)	TOOTH TYPE	TOOTH LABEL	PRICE (EX GST)
	OAV13B-01-03	1-3.9	V13	V13	\$18
	OAPC60B-05	4-5.9	PC60	PC60RC	\$15
	OACAT303B-08	6-9.9	CAT303	1U3202RC	\$16
	OACAT312B-12	10-14.9	CAT312	1U3252RC	\$32
	OACAT320B-20	15-23.9	CAT320	530-56 50	\$42

RIPPER TOOTH	PRODUCT CODE	TONNAGE (ton)	TOOTH TYPE	TOOTH LABEL	PRICE (EX GST)
	OACAT303R-01-05	1-5.9	CAT303	1U3202RC	\$16
	OACAT312R-03-08	3-9.9	CAT312	1U3252RC	\$32
	OAD85R-12	10-14.9	D85	D85C	\$144
	OAD85-20	15-23.9	D85	D85C	\$144

GRAPPLE TOOTH	PRODUCT CODE	TONNAGE (ton)	TOOTH TYPE	TOOTH LABEL	PRICE (EX GST)
	OA5KG-01-05	1-5.9	5K	5KC3-S	\$13
	OAPC60G-02-05	2-5.9	PC60	PC60RC	\$15
	OAPC100G-08	6-9.9	PC100	PC100RC	\$32
	OADH150G-12	10-14.9	DH150	2713-1221 RC	\$35
	OADH220G-20	15-23.9	DH220	2713-1217RC-2	\$65

PIPE LAYING ATTACHMENT	PRODUCT CODE	TONNAGE (ton)	TUBE DIAMETER (mm)	PRICE (EX GST)
	OARPL-01	1-1.9	40	\$350
	OARPL-12	10-14.9	70	\$416
	OARPL-20	15-23.9	70	\$480

TWIN PRONG FORK	PRODUCT CODE	TONNAGE (ton)	PRICE (EX GST)
	OATP-05	4-5.9	\$448
	OATP-12	10-14.9	\$768

*To suit a RHS type thumb

AUGER PARTS



AUGERS

WIDTH	EARTH TRADE PRICE (EX GST)	TUNGSTEN TRADE PRICE (EX GST)	ROCK TRADE PRICE (EX GST)
			
100mm	\$600	\$650	\$660
150mm	\$610	\$690	\$700
200mm	\$630	\$750	\$770
250mm	\$680	\$790	\$830
300mm	\$750	\$850	\$900
350mm	\$820	\$900	\$950
400mm	\$860	\$960	\$1,020
450mm	\$950	\$1,070	\$1,140
500mm	\$1,070	\$1,190	\$1,260
600mm	\$1,210	\$1,350	\$1,430

AUGER EXTENSION

LENGTH	PRICE (EX GST)
500mm	\$330
800mm	\$360
1000mm	\$390
1500mm	\$440
2000mm	\$490

HANGING BRACKET

SIZE	SINGLE PIN PRICE (EX GST)	DOUBLE PIN PRICE (EX GST)
25mm	\$275	\$550
30mm	\$275	\$550
35mm	\$275	\$550
38mm	\$350	\$650
40mm	\$350	\$650
45mm	\$450	\$650
50mm	-	\$700

HOW TO MEASURE YOUR HITCH

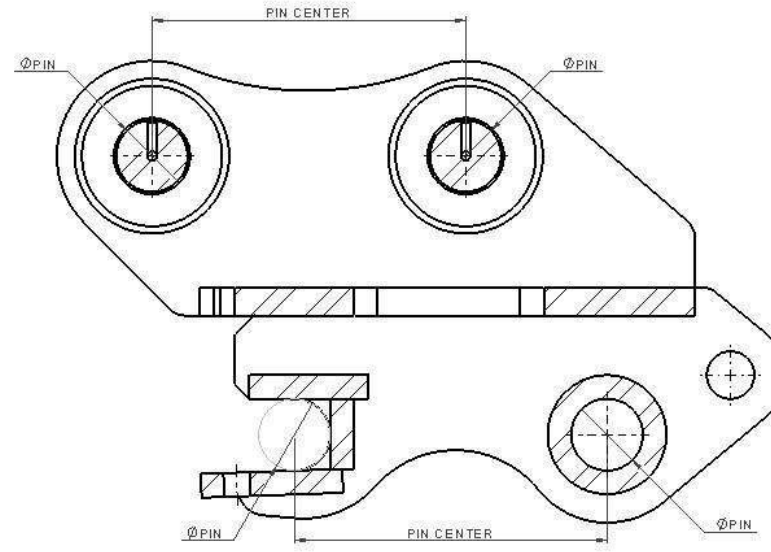
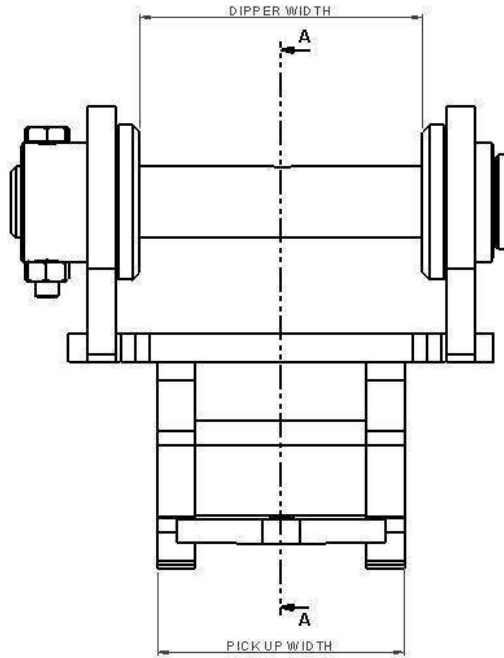

SECTION A-A
SCALE 1 : 1.7

TOP PIN DIAMETER (mm): _____

TOP PIN CENTRES (mm): _____

DIPPER WIDTH/ EARS (mm): _____

PICK-UP WIDTH/ JAW (mm): _____

BOTTOM PIN CENTRES (mm): _____

BOTTOM PIN DIAMETER (mm): _____

SPECIFY IF:

PULL-PIN COUPLER

HYDRAULIC QUICK COUPLER